



Valliscó

WELCOME

Thank you for choosing our company's products. To ensure proper installation and use of this product, please read this manual carefully and keep it in a safe place for future reference.

IMPORTANT TIPS

1. In accordance with local regulations and product guidelines, please refrain from disassembling or tampering with the electronic circuits. Any product issues or damages resulting from such actions are not the responsibility of the brand or seller.
2. Do not disassemble or clean this product with water without proper authorization, as this may cause damage.
3. To clean the fan, please remove the entire unit and use a dry brush and hair dryer for cleaning. Thank you!

BEFORE INSTALLATION

1. Verify that the package is complete and ensure all parts are included.
2. Confirm that the fan size is compatible with your duct opening.
3. Test the fan to ensure it is functioning properly when plugged in.

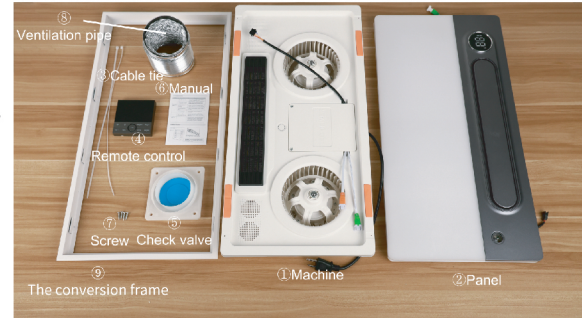

Parts

Name	①Machine	②Panel	③Cable tie	④Remote control	⑤Check valve	⑥Manual	⑦Screw	⑧Ventilation pipe	⑨The conversion frame
Amount	1	1	2	1	1	1	4	1	1

⑤ **Check valve:** If your home does not have a pre-installed exhaust duct and is close to the wall, you may drill a hole according to the size of our air valve.

Note: The following parameters are for reference only. For accurate details, please refer to the specifications listed on the product nameplate.

Series No.	Machine Size	Panel Size	V/Hz	Air Velocity	Noise
HKJC-4H1YB2800W	11.81" x 23.62"	12.4" x 24.21"	110V,60Hz	140 CFM	≤35dB
Rated Power	Heating Power	Ventilation Power	Blowing Power	Lighting Power	Diameter Of Ventilation Duct
1900W	1800W	40W	40W	24W	4"

INSTALLATION

- Note:
1. Please read the instructions carefully before installation.
 2. Installation and wiring shall be completed by professional electricians.
 3. Be sure to cut off the power supply before installation to prevent electric shock.

STEP 1

Connect the panel ② to the machine ①. (Before testing the machine, it is necessary to connect the panel for functional testing)



STEP 2

Perform a power-on and code-matching function test. After confirming that the test is successful, disconnect the panel from the main unit. (After testing, please remove the panel to facilitate subsequent installation.)



Power-on



Testing

Pairing Code: After the machine is powered on, press and hold the “” button on the remote control ④ for more than 2 seconds to enter the pairing mode. Keep the button pressed, then power on the main unit. When you hear a "beep" sound, the pairing is successful. Then, use the buttons to test all functions of the main unit.

STEP 3

Use tools to secure the ventilation pipe⑧ to the air outlet with Cable tie③ and fasten it in place.



Tip: Due to the specially designed air outlet for increased wind speed, please ensure to follow the steps to connect the ventilation duct provided inside, and then connect it to the pre-installed ventilation duct in the house to avoid any incompatibility issues.

STEP 4

Use tools to cut a 24.02*12.20 inches opening on the top.

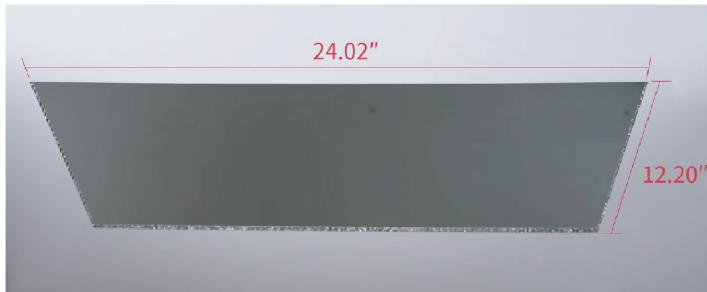

STEP 7

Use a power socket to connect the power supply.

Tip: If there is no power socket in your home and you need to connect the power cable directly, please have a professional handle the installation. Cut off the plug and connect the wires as follows:

Black wire: Live wire (L)

White wire: Neutral wire (N)

Green wire: Ground wire (G).



STEP 8

Tilt the machine ① and place it into the upper opening, and place the four support feet onto the conversion frame.



STEP 9

Correctly connect the panel to the main unit to ensure the machine can operate safely.

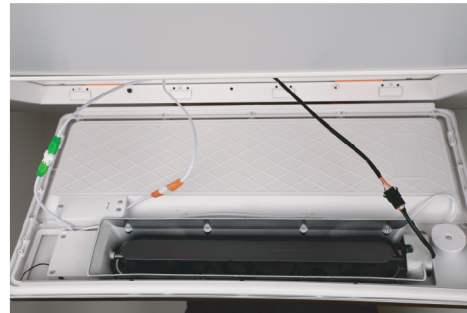

Check Orientation:
Ensure the ventilation grille on the panel is aligned with the air outlet (black part) on the host for proper airflow.

REMOTE CONTROL

The remote control can be fixed to the wall with adhesive or nails.

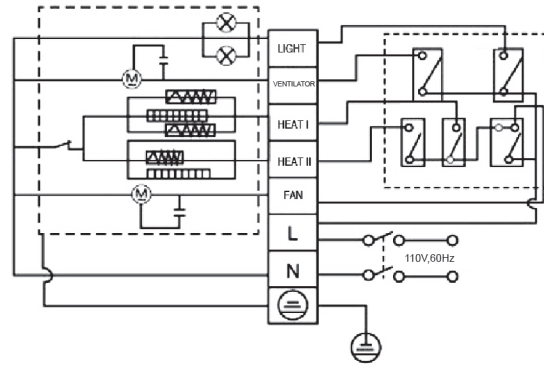
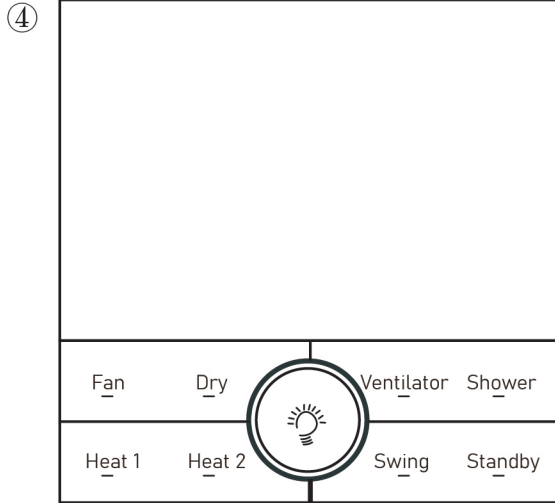

Electrical wiring diagrams



Standby: Turn off all functions except lighting. If the warm air runs for 30 seconds, the fan will turn off intelligently.



Swing: Turn on the swing function.

REMOTE CONTROL

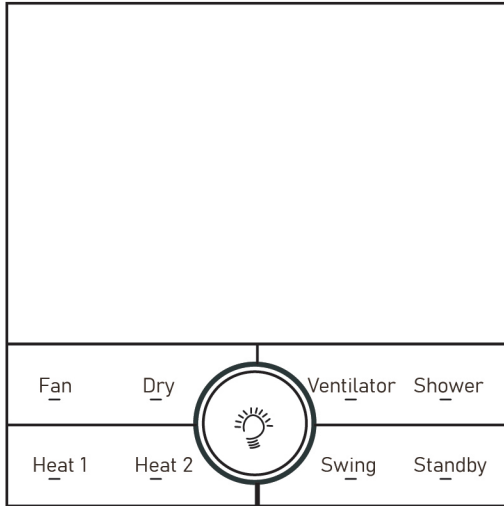

Fan: air supply mode, such as with swing leaf open at the same time.



Dry: Turn on all heating and ventilation functions with one click



Ventilator: Indoor and outdoor air exchange, when the heating function is running (not operable)

REMOTE CONTROL

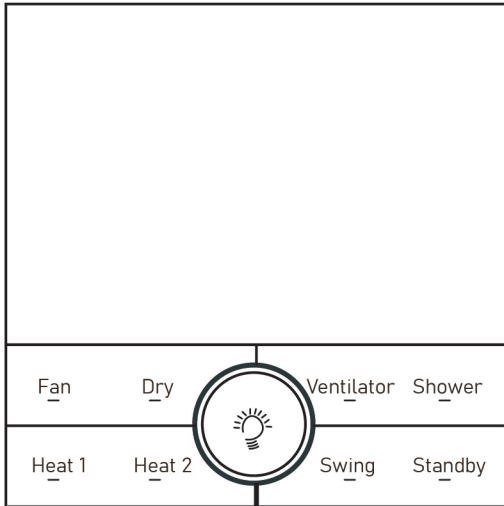

Shower: Turn on the warm air + lighting function, and the blower function will start automatically. Turn off the bath function, turn off the air intelligently after 30 seconds, and the lighting is not turned off.



Heat1/Heat2 : Turn on the warm air function, and the blowing function starts automatically. Turn off the warm air function and turn it off intelligently after blowing for 30 seconds.

WARRANTY

Our warranty plan assures that the products we sell are free from manufacturing defect. for one year from the date of purchase, We will address any issues according to the specified warranty terms. Applicable to items bought from us or authorized dealers, the warranty covers defects, malfunctions, or unusable products, effective from the purchase date and valid for one year. We will replace or refund defective products during this period, excluding misuse, abuse, or normal wear and tear damages. This warranty is non-transferable.

Return Process



Damaged? Wrong item?
Missing Parts?



Get your order information ready, photos will be very helpful.



Contact us.



Our service team will take care of your inquiries accordingly.



At last, we shall provide a suitable solution to you.

COMMON PROBLEM

Issue	Possible Cause	Solution
Controller not responding	Connection disconnected	Check power supply and re-pair the code
Fan not spinning	Circuit not connected	Check power supply and ensure wiring is correct
Excessive noise	Air duct blocked	Clean the air duct and check if the exhaust port is clear
Heating function not working Heating function not	Overheat protection triggered	Power off for 10 minutes, then restart
Cannot operate except for lighting function not working	Operation locked in purification mode, only lighting can be controlled	Press the power-off button and wait for shutdown, then it can be used normally
Fan continues to spin after turning off heating	Cooling protection, fan spins for 20-30 seconds after shutdown	Normal protection

Valliscó

STEP 5

Please note, before installing the conversion frame ⑨, use a tool to slightly lift the side clips to facilitate easy installation of the panel later. However, avoid applying excessive force when lifting or bending, as this may cause the clips to not seal tightly.



STEP 6

Place the conversion frame into the pre-cut hole and use screws to secure it in place. Ensure the frame is firmly installed by double-checking its stability to avoid any issues.



STEP 10

When installing the panel, align all four sides with the conversion frame and snap them into the pre-set clips.



Note: It is necessary to ensure that all four sides of the panel are simultaneously inserted into the conversion frame.

STEP 11

After the panel installation is completed, peel off the removable protective film. Installation is complete. Use remote control switch to control the machine.

